

ducasa

AVANT-DGS

Thermal Electric Radiator

Operating and Installation Instructions

(Read these instructions carefully and retain for future reference)

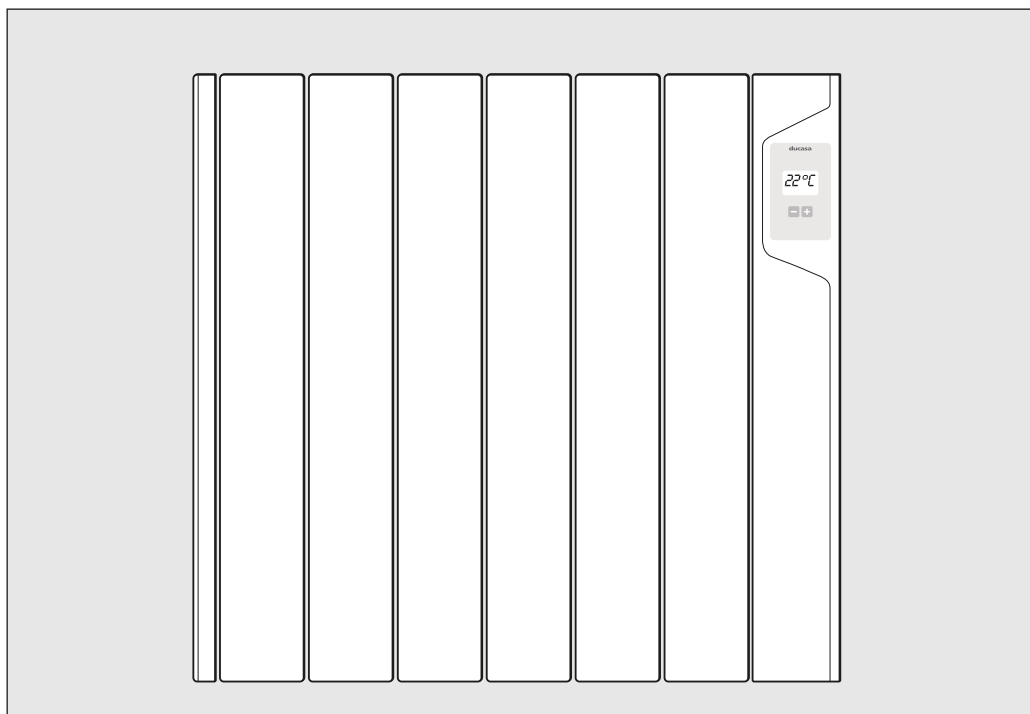

Models:

AVANT-DGS 350
AVANT-DGS 500
AVANT-DGS 800
AVANT-DGS 1000
AVANT-DGS 1300
AVANT-DGS 1500
AVANT-DGS 1800

NOTE:

A qualified electrician must carry out the electrical installation of this radiator. The Electrical installation must comply with the current UK regulations. Any claim on the warranty could be invalid if these requirements have not been met.

CONTENTS

General / Important Information	Page 2
Installation Instructions	Page 4
Electrical Power Supply	
Location of Radiator	
Mounting of Radiator	
Operating Instructions	Page 7
Controls	
Switching On	
Setting the temperature	
Quick guide	Page 8
Preset weekly Programme	Page 10-11
Maintenance and Care	Page 12

GENERAL INFORMATION

The Avant DGS has a special cast aluminium body specifically designed to assure maximum rate of heat radiation; the air circulation channels providing a very efficient convection effect.

Special heat conducting fluid in the aluminium body. A unique process provides bubble free filling so that the fluid delivers warmth from the heating element in a totally uniform way, ensuring that the entire surface of radiator provides comfortable heat.

Monotube heating element to ensure maximum heat output.

Designed and fabricated in accordance with EN 60335-1, EN 60335-2 and EN 55014 (regulations for domestic appliances)
Standard colour White (RAL 9016)
Class I
Wall mounted (by quick fixing system)
Bi-metallic thermal cut-out
On-off main switch
Overheat protection
Key-pad locking (anti-tamper)
NTC electronic sensor
Fitted with connecting power cable 1450mm long (without a plug)

Technical Data

MODEL	Number Of Fins	Power Rating (W)	Size (mm)	Net Weight (Kg.)	Fuse Rating
Avant-DGS 350	3	350	340 x 580 x 100	6.9	5 Amp.
Avant-DGS 500	4	500	420 x 580 x 100	8	5 Amp.
Avant-DGS 800	6	800	580 x 580 x 100	12	5 Amp.
Avant-DGS 1000	8	1000	740 x 580 x 100	16	10 Amp.
Avant-DGS 1300	10	1300	900 x 580 x 100	20	10 Amp.
Avant-DGS 1500	12	1500	1060 x 580 x 100	24	10 Amp.
Avant-DGS 1800	12	1800	1060 x 580 x 100	24	10 Amp.

Important Information

See Section "Installation Instructions – Location of Heater" for important notes regarding the siting of the appliance.

Due to the surfaces of the heater becoming hot, it must not be positioned directly against or below inflammable surfaces.

Do not dry clothes or towels on the heater nor leave fabrics, magazines, spray cans, volatile substances or similar objects within 250mm of the heater.

In case of breakdown or damage turn off the appliance at the main On/Off switch and notify the supplier.

If the electricity cable gets damaged it must only be replaced by a technician appointed by the supplier.

This will avoid possible risks and ensure that special tools are available if needed.

This appliance is not intended to be used by persons (incl. children) with limited physical, sensory or mental capabilities, or who lack experience, except for those under supervision or have received instruction in the use of the appliance from a person responsible for their security.

Children must be supervised in order to ensure that they do not play with the appliance.

WARNING: In order to prevent overheating, do not cover this appliance. There has to be free movement of air around all surfaces of the appliance.



This symbol "DO NOT COVER", is placed on the heater as a reminder to the user.

Electrical Connection

A qualified electrician must carry out the electrical installation of this radiator. The electrical installation must comply with the current UK regulations. Any claim on the warranty could be invalid if these requirements have not been met.

The radiator requires a 230/240V 50/60Hz power supply.

Connecting wires:

Brown: Live

Blue: Neutral

Yellow-green: Earth (only for Class I radiators)

The connecting wires must be of the appropriate section, in regards to the length of cable, type of cable and power rating of the apparatus.

The apparatus must be connected into a fused connecting box or a plug fitted with an appropriate sized fuse for the radiator – see Technical Data on Page 3.

We recommend that the connecting box is positioned 10cm to the right of the apparatus and at 15cm above the floor. According to regulations, the apparatus must be connected to the power supply by means of an all-pole circuit breaker with a contact gap of at least 3mm or by a thermal-magnetic circuit breaker.

Location

The ideal place to site the Ducasa radiator is as close as possible to coolest wall in the room but it is not recommended to site the radiator on un-insulated exterior walls, in this case, the part of the wall behind the radiator should be insulated.

In bathrooms, the radiators must not be sited inside the protected area. The control unit switches must not be reachable, directly or indirectly, by a person in the bath or shower.

The radiator, under no circumstances, should be installed below an electric power point.

Choose the location of the radiator in respect of the minimum distances that are indicated in Figure A.

Fig. A

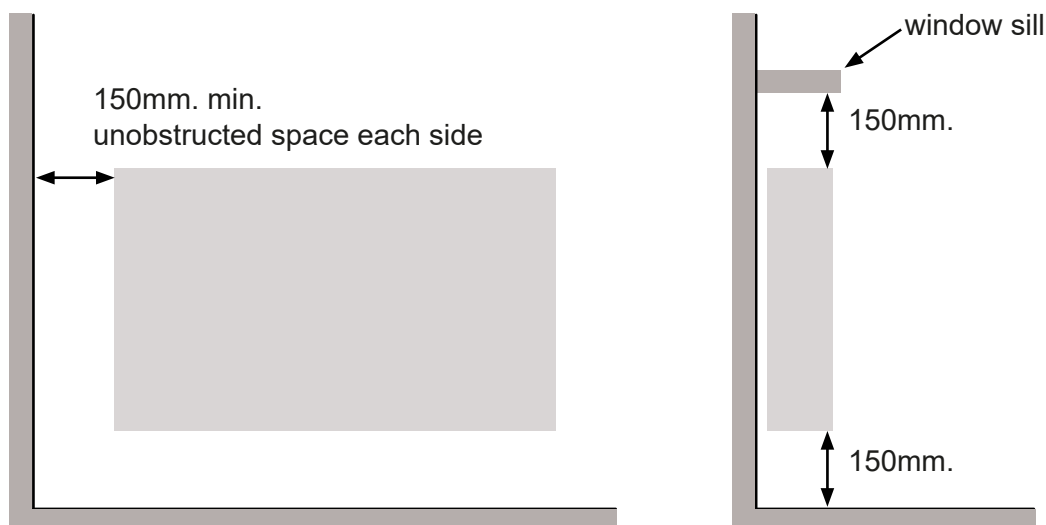

Mounting The Radiator

Place the radiator on the floor, as shown in Figure 1. For radiators with 4, 6, 8 or 10 elements position the supports supplied with the radiator as shown in Figure 1. For radiators with 12 elements the supports should be positioned between the second and third elements on both sides.

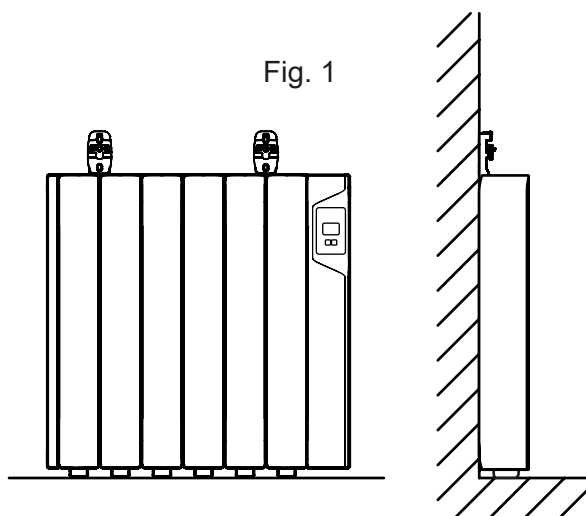

Place the supports between the elements as shown in Figure 2a, mark points on the walls through the fixing holes as shown in Figure 2b. This determines the spacing of the supports. Transfer these marks to whatever height above floor (min. 150mm) that has been decided for the radiator. Fix the supports to the wall with plugs and screws. Be sure that the supports are mounted in the correct position.

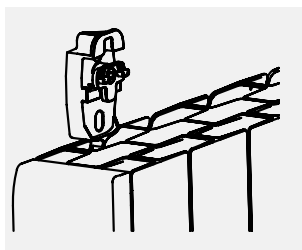

Fig. 2a

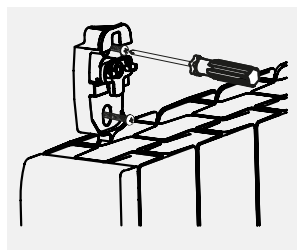

Fig. 2b

Lift the radiator and hang it on the supports, as Figures 3a and 3b.

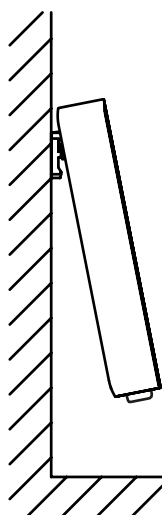

Fig. 3a

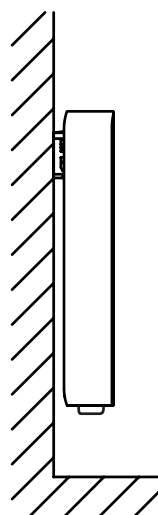
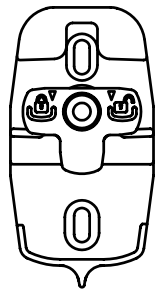
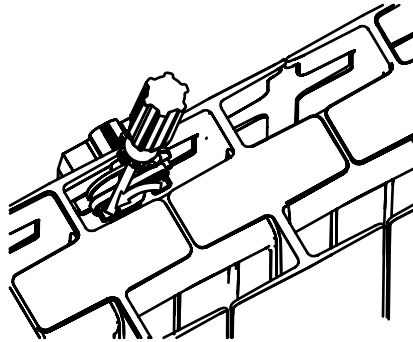

Fig. 3b

As soon as the radiator is hanging on the supports press on the locking plate until a click is heard. See Figure 4. The radiator is now installed.

Fig. 4



FREE

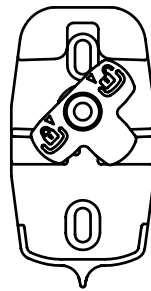

LOCKED

OPERATING INSTRUCTIONS

Controls

The control of the room temperature is by means of an electronic thermostat in the control unit on the right hand side of the radiator. The panel consist of two push-buttons and an LCD display. There is also a main On-Off switch on the right hand side of the control panel.

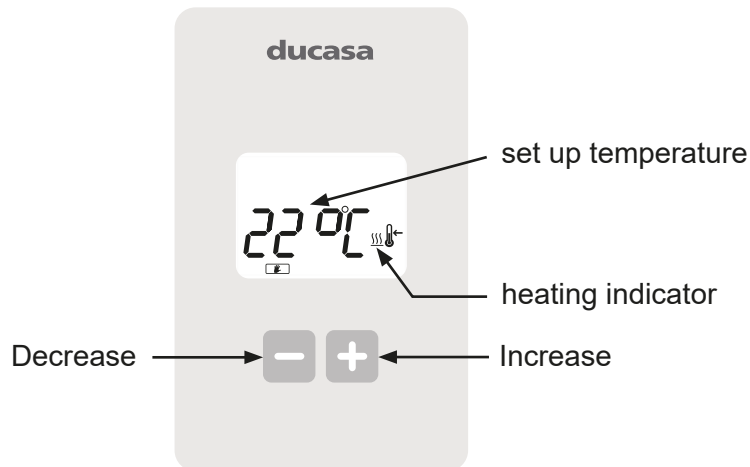

Possible failures of the thermostat:

If the thermostat senses a temperature below -15°C , you will see **OC** displayed on the screen.
If the thermostat senses a temperature above $+50^{\circ}\text{C}$, you will see **SC** displayed on the screen.

Switching On

Once the radiator has been mounted on the wall and correctly connected to the main electricity power supply, press the main On-Off switch.

During use, the control panel will display the set up temperature.

When the radiator is switched on, pressing the + and – buttons will increase/decrease the comfort temperature in increments of 0.5°C . Pressing and holding down either button will rapidly change the setting in increments of 0.5°C ; release the button when the desired temperature is reached. Once the required temperature has been entered and there is no further use of the + and – buttons, the control unit will automatically remember the selected temperature.

Temperature Compensation

Due to the characteristics of the radiator, the control unit has to read the temperature measurement from the lower part of the apparatus, but it is automatically adjusted in relation to the comfort temperature setting. However it is possible to manually adjust this “Thermic Compensation”.

Room temperature, recorded by an ambient thermometer minus Comfort setting (temperature) displayed on the control panel screen = compensation value.

1. Press + button during switch ON with the main switch.
2. Press the + or - buttons to enter the adjustment in increments of 0.1°C . (from -7.0° to 7.0°)
3. If the keyboard is not used for 5 seconds, the thermostat will return to the normal mode.

Example:

A temperature 22°C is measured in a room with a thermometer while the value of the required Comfort temperature on the thermostat 20°C .

The setting for the compensation is therefore: $22 - 20 = 2^{\circ}\text{C}$.

In the temperature compensation mode, the user should put in: $+2^{\circ}\text{C}$.

Keypad Locking (Anti-Tamper)

The keypad can be locked to prevent any unauthorised person (children, people in public places, nurseries, offices, hotels etc.) altering the settings and programming in the control unit. To lock the keypad depress and hold the + and – buttons at the same time. The screen will flash

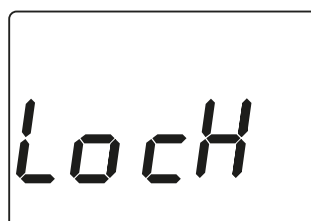

press 3 seconds for Lock

press 3 seconds for unLock

MANUAL MODE

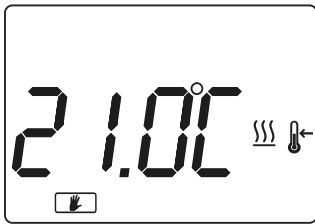

choose MANUAL temp +/-
(21°C factory default)

PROGRAMMING MODE

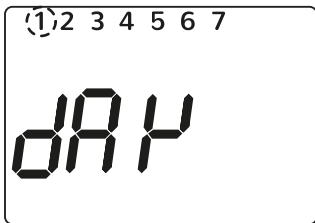

press for 20 seconds
to set TIME and access weekly
programmes



Set DAY (1=Mon, 7=Sun) by pressing
+
then press - to move to next screen



Set HOUR by pressing +
then press - to move to next screen



Set MINUTES by pressing +
then press - to move to next screen

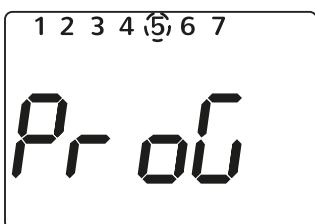

Select pre-set programme 1 to 7
by pressing + and confirm by pressing -
(See separate table for details of programmes)

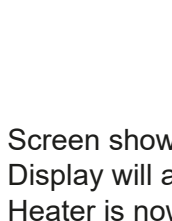
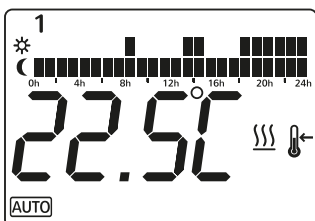

Screen shows current day and programme settings for each hour.
Display will alternate between set temperature and clock
Heater is now in AUTO mode

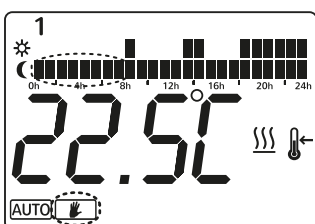

Override set temperature by pressing + or -
MANUAL icon and blocks flash to indicate programme override.
Returns to programmed temperature at next mode or day change.

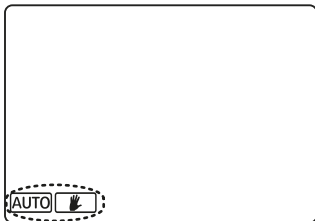

Press both buttons 3 times to choose AUTO or MANUAL mode
 AUTO and MANUAL icons flash
 Select mode with +/- and after 5 seconds of inactivity mode is set

ADDITIONAL FEATURES

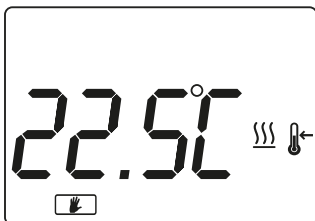

When in MANUAL mode,
 if power is disconnected and then reconnected the last set temperature is retained.

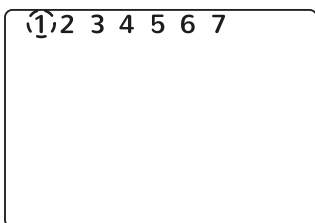

When in AUTO mode,
 if power is disconnected for more than a few minutes the DAY and TIME will need to be re-entered before returning to AUTO.
 The last set temperature will be retained.

Temperature Range 10.5°C - 30°C

Temperature Settings

- ☀ (21°C factory default) Comfort temperature is set using +/- when in MANUAL mode
- ☾ Economy temperature is 3°C less than comfort temperature
- ❄ Frost protection temperature is set at 7°C

OPEN WINDOW DETECTION

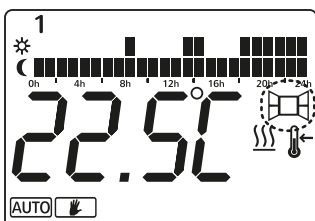

☞ The controller has an OPEN WINDOW feature, active in both MANUAL and AUTO modes.

If temperature drops by 0.6°C a minute for 4 consecutive minutes the heater will switch off for 30 minutes.

OPEN WINDOW icon is shown on the screen



The heater will return to normal heating;

- After 30 minutes
- If the temperature increases by 0.2°C for 1 minute from the point of activation.
- + or - key is pressed

PRESET PROGRAMS 1-7

WEEKLY PROGRAMME 1

Mon-Fri							☀	☀	☀									☀	☀	☀	☀	☀	☀			☀	
																											☾
	☀	☀	☀	☀	☀	☀				☀	☀	☀	☀	☀	☀	☀									☀	☀	☀
	00	01	02	03	04	05	06	07	08	09	10	11	12	13	14	15	16	17	18	19	20	21	22	23			

Sat-Sun								☀	☀	☀	☀	☀	☀	☀	☀	☀	☀	☀	☀	☀	☀	☀	☀			☀
																										☾
	☀	☀	☀	☀	☀	☀	☀																		☀	☀
	00	01	02	03	04	05	06	07	08	09	10	11	12	13	14	15	16	17	18	19	20	21	22	23		

WEEKLY PROGRAMME 2

Mon-Fri							☀	☀											☀	☀	☀	☀			☀	
																										☾
	☀	☀	☀	☀	☀	☀			☀	☀	☀	☀	☀	☀	☀	☀	☀							☀	☀	☀
	00	01	02	03	04	05	06	07	08	09	10	11	12	13	14	15	16	17	18	19	20	21	22	23		

Sat-Sun								☀	☀										☀	☀	☀	☀	☀	☀		☀
																										☾
	☀	☀	☀	☀	☀	☀	☀			☀	☀	☀	☀	☀	☀	☀								☀	☀	
	00	01	02	03	04	05	06	07	08	09	10	11	12	13	14	15	16	17	18	19	20	21	22	23		

WEEKLY PROGRAMME 3

Mon-Fri								☀	☀	☀	☀	☀	☀	☀	☀	☀	☀	☀	☀	☀	☀	☀			☀	
																										☾
	☀	☀	☀	☀	☀	☀	☀																	☀	☀	☀
	00	01	02	03	04	05	06	07	08	09	10	11	12	13	14	15	16	17	18	19	20	21	22	23		

Sat-Sun								☀	☀	☀	☀	☀	☀	☀	☀	☀	☀	☀	☀	☀	☀	☀			☀	
																										☾
	☀	☀	☀	☀	☀	☀	☀																	☀	☀	☀
	00	01	02	03	04	05	06	07	08	09	10	11	12	13	14	15	16	17	18	19	20	21	22	23		

WEEKLY PROGRAMME 4

Mon-Fri							☀	☀	☀										☀	☀	☀	☀			☀	
																										☾
	☀	☀	☀	☀	☀	☀				☀	☀	☀	☀	☀	☀	☀	☀							☀	☀	☀
	00	01	02	03	04	05	06	07	08	09	10	11	12	13	14	15	16	17	18	19	20	21	22	23		

Sat-Sun							☀	☀	☀										☀	☀	☀	☀	☀	☀		☀
																										☾
	☀	☀	☀	☀	☀	☀				☀	☀	☀	☀	☀	☀	☀								☀	☀	
	00	01	02	03	04	05	06	07	08	09	10	11	12	13	14	15	16	17	18	19	20	21	22	23		

MAINTENANCE AND CARE

Ducasa radiators require very little maintenance.

The surfaces of the radiator must not be cleaned with an abrasive product or those containing granular substances.

We recommend regular cleaning with PH neutral products.

In order to clean the radiator, it is recommended that the electric power is switched off.

CORRECT DISPOSAL OF THIS PRODUCT

(Waste Electrical & Electronic Equipment)

(Applicable in the European Union and other European countries with separate collection systems)

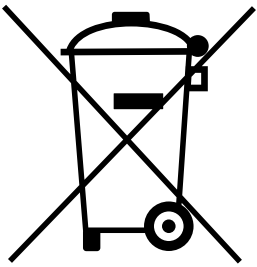

This marking shown on the product or its literature, indicates that it should not be disposed of with other household wastes at the end of its working life.

To prevent possible harm to the environment or human health from uncontrolled waste disposal, please separate this from other types of wastes and recycle it responsibly to promote the sustainable reuse of material resources.

Household users should contact either the retailer where they purchased this product, or their local government office, for details of where and how they can take this item for environmentally safe recycling.

Business users should contact their supplier and check the terms and conditions of the purchase contract. This product should not be mixed with other commercial wastes for disposal.



UK Distributor of Ducasa Products:

Heattend Products Ltd

Web: www.heattend.co.uk

Email: enquiries@heattend.co.uk