

# ducasa

## AVANT-DGP

Thermal Electric Radiator

Operating and Installation Instructions

(Read these instructions carefully and retain for future reference)

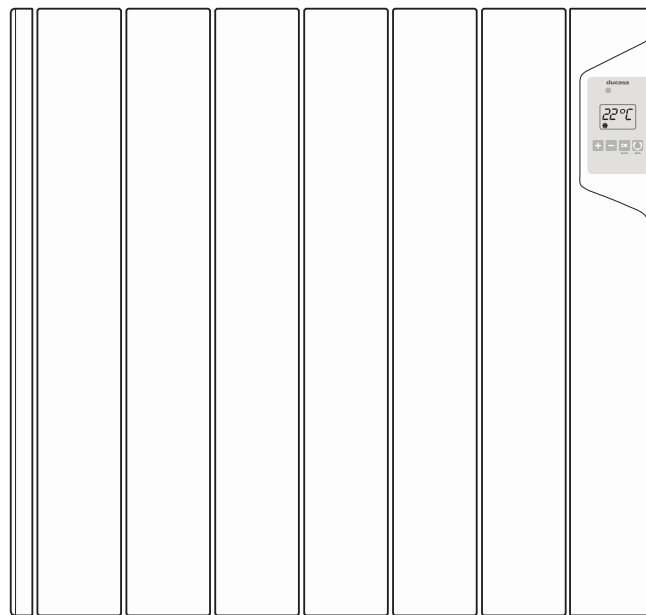

### Models:

<b>AVANT-DGP</b>	<b>350</b>
<b>AVANT-DGP</b>	<b>800</b>
<b>AVANT-DGP</b>	<b>1000</b>
<b>AVANT-DGP</b>	<b>1300</b>
<b>AVANT-DGP</b>	<b>1500</b>
<b>AVANT-DGP</b>	<b>1800</b>

### NOTE:

**A qualified electrician must carry out the electrical installation of this radiator. The Electrical installation must comply with the current UK regulations. Any claim on the warranty could be invalid if these requirements have not been met.**

## CONTENTS

General / Important Information	Page 3
Installation Instructions	Page 5
❖ Electrical Power Supply	
❖ Location of Radiator	
❖ Mounting of Radiator	
Operating Instructions	Page 8
❖ Controls	
❖ Switching On	
❖ Setting the temperature	
❖ Selection Of Mode	
❖ Programming	
❖ Keypad Locking (Anti-Tamper)	
Maintenance and Guarantee	Page 12

## **GENERAL INFORMATION**

The Avant DGP has a special cast aluminium body specifically designed to assure maximum rate of heat radiation; the air circulation channels providing a very efficient convection effect.

Special heat conducting fluid in the aluminium body. A unique process provides bubble free filling so that the fluid delivers warmth from the heating element in a totally uniform way, ensuring that the entire surface of radiator provides comfortable heat.

Monotube heating element to ensure maximum heat output.

- ‡ Designed and fabricated in accordance with EN 60335-1, EN 60335-2 and EN 55014 (regulations for domestic appliances)
- ‡ Standard colour White (RAL 9016)
- ‡ Class I or Class II
- ‡ Wall mounted (by quick fixing system)
- ‡ Capillary safety limiter
- ‡ On-off main switch (illuminated)
- ‡ Overheat protection
- ‡ Programmable digital control with LCD display
- ‡ Comfort, Economy and Frost Protection settings
- ‡ Key-pad locking (anti-tamper)
- ‡ Programmable by infrared remote control (Ducasa Remote) – optional
- ‡ NTC electronic sensor
- ‡ Fitted with connecting power cable 1450mm long (without a plug)

## Technical Data

MODEL	Number of Fins	Power Rating (W)	Size (mm)	Net Weight (Kg.)	Fuse rating (Amp.)
Avant-DGP 350	3	350	340 x 580 x 100	6.9	5 A
Avant-DGP 500	4	500	420 x 580 x 100	8	5 A
Avant-DGP 800	6	800	580 x 580 x 100	12	5 A
Avant-DGP 1000	8	1000	740 x 580 x 100	16	10 A
Avant-DGP 1300	10	1300	900 x 580 x 100	20	10 A
Avant-DGP 1500	12	1500	1060 x 580 x 100	24	10 A
Avant-DGP 1800	12	1800	1060 x 580 x 100	24	10 A

### Important Information

See Section “Installation Instructions – Location of Heater” for important notes regarding the siting of the appliance.

Due to the surfaces of the heater becoming hot, it must not be positioned directly against or below inflammable surfaces.

Do not dry clothes or towels on the heater nor leave fabrics, magazines, spray cans, volatile substances or similar objects within 250mm of the heater.

In case of breakdown or damage turn off the appliance at the main On/Off switch and notify the supplier.

If the electricity cable gets damaged it must only be replaced by a technician appointed by the supplier. This will avoid possible risks and ensure that special tools are available if needed

This appliance is not intended to be used by persons (incl. children) with limited physical, sensory or mental capabilities, or who lack experience, except for those under supervision or have received instruction in the use of the appliance from a person responsible for their security.

Children must be supervised in order to ensure that they do not play with the appliance.

**WARNING:** In order to prevent overheating, do not cover this appliance. There has to be free movement of air around all surfaces of the appliance.



This symbol “DO NOT COVER”, is placed on the heater as a reminder to the user.

# **INSTALLATION INSTRUCTIONS:**

## ***Electrical Connection***

A qualified electrician must carry out the electrical installation of this radiator. The electrical installation must comply with the current UK regulations. Any claim on the warranty could be invalid if these requirements have not been met.

The radiator requires a 230/240V 50/60Hz power supply.

Connecting wires:

<b>Brown:</b>	<b>Live</b>
<b>Blue or grey:</b>	<b>Neutral</b>
<b>Yellow-green:</b>	<b>Earth (only for Class I radiators)</b>
<b>Black:</b>	<b>Pilot wire (if required for external programmer)</b>

**IF PILOT WIRE IS NOT REQUIRED INSULATE BLACK CABLE TO ENSURE IT DOES NOT COME INTO CONTACT WITH ANY OTHERS WIRES OR TERMINALS.**

The connecting wires must be of the appropriate section, in regards to the length of cable, type of cable and power rating of the apparatus.

The apparatus must be connected into a fused connecting box or a plug fitted with an appropriate sized fuse for the radiator – see Technical Data on Page 4.

We recommend that the connecting box is positioned 10cm to the right of the apparatus and at 15cm above the floor.

According to regulations, the apparatus must be connected to the power supply by means of an all-pole circuit breaker with a contact gap of at least 3mm or by a thermal-magnetic circuit breaker with a contact gap of at least 3mm or by a thermal-magnetic circuit breaker.

## ***Location***

The ideal place to site the Ducasa radiator is as close as possible to coolest wall in the room but it is not recommended to site the radiator on un-insulated exterior walls, in this case, the part of the wall behind the radiator should be insulated.

In bathrooms, the radiators must not be sited inside the protected area. The control unit switches must not be reachable, directly or indirectly, by a person in the bath or shower.

The radiator, under no circumstances, should be installed below an electric power point.

Choose the location of the radiator in respect of the minimum distances that are indicated in Figure A.

**Fig. A**

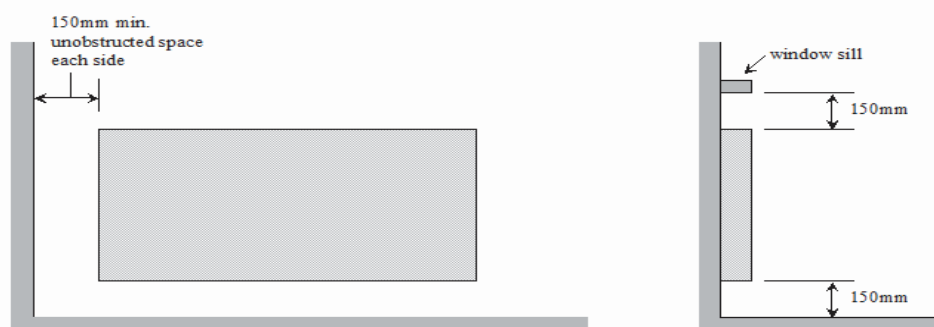

## Mounting The Radiator

Place the radiator on the floor, as shown in Figure 1. For radiators with 4, 6, 8 or 10 elements position the supports supplied with the radiator as shown in Figure 1. For radiators with 12 elements the supports should be positioned between the second and third elements on both sides.

Fig. 1

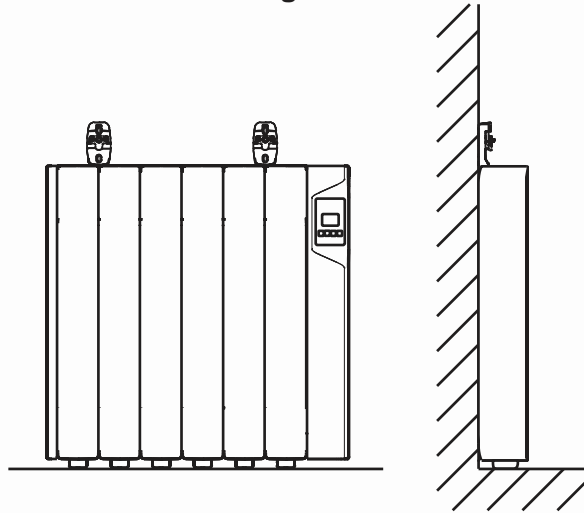

Place the supports between the elements as shown in Figure 2a, mark points on the walls through the fixing holes as shown in Figure 2b. This determines the spacing of the supports. Transfer these marks to whatever height above floor (min. 150mm) that has been decided for the radiator. Fix the supports to the wall with plugs and screws. Be sure that the supports are mounted in the correct position.

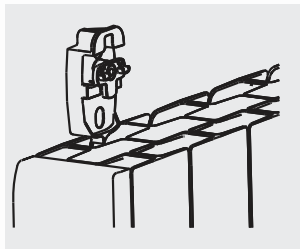

Fig. 2a

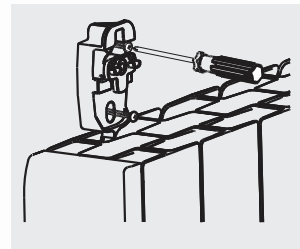

Fig. 2b

Lift the radiator and hang it on the supports, as Figures 3a and 3b.

Fig. 3a

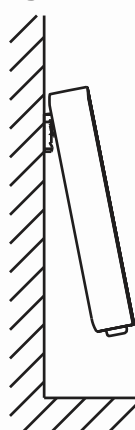
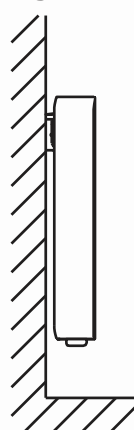
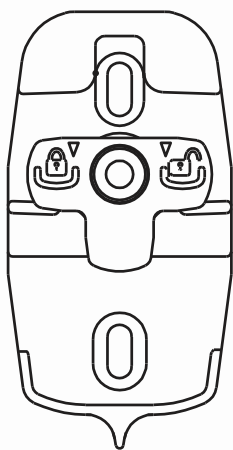
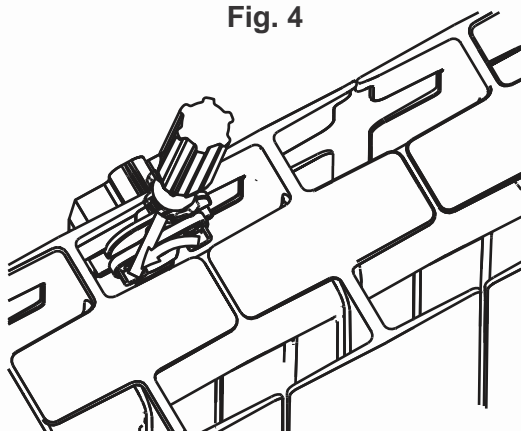

Fig. 3b



As soon as the radiator is hanging on the supports press on the locking plate until a click is heard. See Figure 4. The radiator is now installed.

Fig. 4



FREE

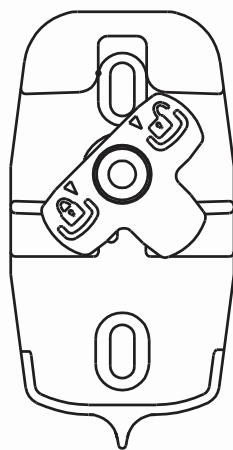

LOCKED

# OPERATING INSTRUCTIONS:

## Controls

The control of the room temperature is by means of an electronic thermostat in the control unit on the right hand side of the radiator. The panel consist of four push-buttons and an LCD display. There is also a main On-Off switch on the right hand side of the control panel.

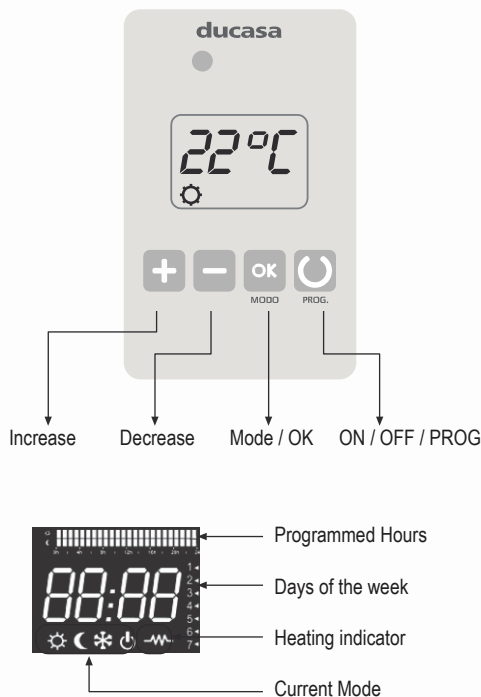

Possible failures of the thermostat:

If the thermostat senses a temperature below  $-15^{\circ}\text{C}$ , you will see OC displayed on the screen.  
If the thermostat senses a temperature above  $+50^{\circ}\text{C}$ , you will see SC displayed on the screen.

## Switching On

Once the radiator has been mounted on the wall and correctly connected to the main electricity power supply, press the main On-Off switch.

Now press the ON/OFF/PROG switch on the control panel.

When you switch on the radiator the microprocessor reads the memory in the control unit in order to load the last selected mode. When switched on for the first time the memory is empty and the display will flash constantly until you set the Comfort temperature.

During use, the control panel will display the temperature and the current operating mode set by the user.

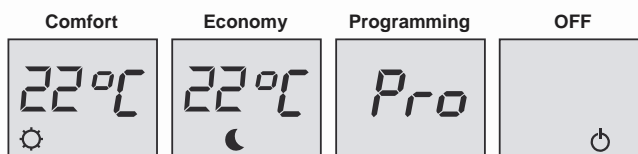



The symbol  will indicate that the heating element is in operation.

## Setting The Comfort and Economy Temperature



To set the comfort or economy temperatures the heater must be in the relevant mode i.e. select economy mode to set economy temperature and comfort mode for comfort temperature.

When the mode is selected, pressing the + and – buttons will increase/decrease the temperature in increments of 1°C. Pressing and holding down either button will rapidly change the setting in increments of 1°C; release the button when the desired temperature is reached. Once the required temperature has been entered and there is no further use of the + and – buttons, the control unit will automatically memorise the selected temperature.

**Please note:** The comfort and economy temperatures are linked, there is a 3°C difference between the two. E.g. if the comfort temperature is 20°C the economy temperature will be 17°C. If you change the economy temperature, the comfort temperature will also change. If you change the comfort temperature the economy temperature will change.

## Selection Of Mode

Press the Mode/OK button to select the operating mode.

By each press of the button the thermostat moves from one mode to another mode, Comfort , Economy  and Programming *Pro*

In order to access the frost protection mode press and hold down the button Mode/OK until the corresponding icon  is displayed on the screen.

MODE	DESCRIPTION
COMFORT	Select comfort temperature with the button (+), (-) (-). Radiator will heat room to required comfort temperature until manually switched off
ECONOMY	The economy temperature is fixed 3°C lower than the set comfort temperature. Any changes to the economy temperature will change the comfort temperature and vice versa
PROGRAMME	Heater will operate at the times and modes set in the programme (see Programming instructions or use optional Ducasa handheld controller) i.e. comfort, economy or frost protection.
FROST PROTECTION	Radiator operates when temperature is less than 7°C
OFF	Radiator switched off

## Programming

- Start with the screen displaying the --:-- symbol or clock (hour : minutes) (OFF mode)
- Press and hold down (min. 5secs.) the ON/OFF/PROG  $\cup$  button in order to go to the manual Programming mode (Pro) *Pro*.
- Select the operating mode hour by hour by pressing the  $+$  button and then the Mode/OK button to validate.

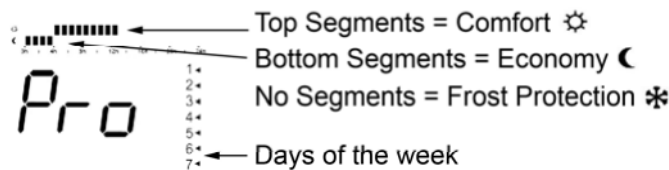

- Repeat the operation for each hour of each day of the week. At the end of programming day 7, the parameters are automatically saved and the display changes to the hour adjustment mode to make sure that the time is valid. Adjust the time if necessary or validate to return to the OFF mode.
- To move the programming timetables use the  $-$  (decrease) button. This enables you to move the time usage without changing the programming. Pressing and holding down this button accelerates the process.
- To return to the Comfort or Economy modes press the Mode/OK button.

## Setting The Time

- Make sure that the thermostat is in the shutdown position or press ON/OFF/PROG  $\cup$  in order to go to the shutdown position.
- Press and hold down (min. 5secs.) the ON/OFF/PROG  $\cup$  button in order to go to the manual Programming mode (PRO) *Pro*.
- Press the ON/OFF/PROG  $\cup$  button.
- Select the day by using the  $+$  and  $-$  buttons and press the Modo/OK button to validate.
- Adjust the time by using the  $+$  and  $-$  buttons and press the Modo/OK button to validate. The validation causes a return to shutdown position.

## ***Temperature Compensation***

Due to the characteristics of the radiator, the control unit has to read the temperature measurement from the lower part of the apparatus, but it is automatically adjusted in relation to the comfort temperature setting. However it is possible to manually adjust this "Thermic Compensation".

Room temperature, recorded by an ambient thermometer minus Comfort setting (temperature) displayed on the control panel screen = compensation value.

1. Put the thermostat in the OFF mode by pressing the ON/OFF/PROG  $\cup$  button.
2. Press and hold down the Mode/OK button until the 0.0 is displayed on the screen.
3. Press the  $+$  and  $-$  buttons to enter the adjustment in increments of 0.1°C.
4. Press the Mode/OK button to return to the OFF mode.
5. Reset the radiator to the mode required.

Example:

- ‡ A temperature 22°C is measured in a room with a thermometer while the value of the required Comfort temperature on the thermostat 20°C.
- ‡ The setting for the compensation is therefore:  $22 - 20 = 2^\circ\text{C}$ .
- ‡ In the temperature compensation mode, the user should put in:  $+2^\circ\text{C}$ .

## ***Keypad Locking (Anti-Tamper)***

The keypad can be locked to prevent any unauthorised person (children, people in public places, nurseries, offices, hotels etc.) altering the settings and programming in the control unit. To lock the keypad depress and hold the  $+$  and  $-$  buttons at the same time. The screen will flash; now validate by pressing Mode/OK.

## ***Ducasa Digital Programmer***

The Avant DGP radiator can also be controlled via the Ducasa handheld controller.

## **MAINTENANCE AND CARE**

Ducasa radiators require very little maintenance.

The surfaces of the radiator must not be cleaned with an abrasive product or those containing granular substances.

We recommend regular cleaning with PH neutral products.

In order to clean the radiator, it is recommended that the electric power is switched off.

## **Guarantee**

Your appliance is guaranteed for two years from the date of purchase – during this period we will repair or exchange, at our discretion, any faulty or defective parts providing the appliance has been used in accordance with the operating & installation instructions and has not been misused or mistreated in any way.

Any unauthorised repair or attempted repair will invalidate the guarantee.

This guarantee is additional to your statutory rights.

In the unlikely event of a problem with your appliance please contact your supplier.

## **Correct Disposal of This Product**

**(Waste Electrical & Electronic Equipment)**

**(Applicable in the European Union and other European countries with separate collection systems)**



This marking shown on the product or its literature, indicates that it should not be disposed of with other household wastes at the end of its working life.

To prevent possible harm to the environment or human health from uncontrolled waste disposal, please separate this from other types of wastes and recycle it responsibly to promote the sustainable reuse of material resources.

Household users should contact either the retailer where they purchased this product, or their local government office, for details of where and how they can take this item for environmentally safe recycling.

Business users should contact their supplier and check the terms and conditions of the purchase contract. This product should not be mixed with other commercial wastes for disposal.

### **UK Distributor of Ducasa Products:**

Heattend Products Ltd

Web: [www.heattend.co.uk](http://www.heattend.co.uk)

Email: [enquiries@heattend.co.uk](mailto:enquiries@heattend.co.uk)